











HOMAPAL® SRM SCRATCH RESISTANT MATT

TECHNICAL DATA SHEET

MAGNETIC BOARDS



	8296 SRM Magnetic Board White SRM	8298 SRM Magnetic Board Light Grey SRM	8295 SRM Magnetic Board Stone Grey SRM	8293 SRM Magnetic Board Macchiato SRM	8231 SRM Magnetic Board Alu Crossed-Brushed Natural SRM
 Sheet-Size a: 2440 x 1220 mm b: 3050 x 1220 mm	a,b	a, b	a, b	a,b	a,b
Net-format	-0,5 mm	-0,5 mm	-0,5 mm	-0,5 mm	-0,5 mm
 Thickness	1,0	1,0	1,0	1,0	1,0
 Weight [kg/m²]	2,9	2,9	2,9	2,9	2,9
 Surface Material: Finish:	Melamine UV-Laquer	Melamine UV-Laquer	Melamine UV-Laquer	Melamine UV-Laquer	Aluminium UV-Laquer
 Balancing	011 SR or front decor	011 SR or front decor	011 SR or front decor	011 SR or front decor	011 SR or front decor
 Tolerances Thickness: Length: Width: Flatness:	±0,18 mm +100 mm/ -0 mm +100 mm/ -0 mm ≤ 100 mm/m	±0,18 mm +100 mm/ -0 mm +100 mm/ -0 mm ≤ 100 mm/m	±0,18 mm +100 mm/ -0 mm +100 mm/ -0 mm ≤ 100 mm/m	±0,18 mm +100 mm/ -0 mm +100 mm/ -0 mm ≤ 100 mm/m	±0,18 mm +100 mm/ -0 mm +100 mm/ -0 mm ≤ 100 mm/m
 Postforming	not possible	not possible	not possible	not possible	not possible
 Processing	at max. temperature of 60° C and max. pres- sure of 0,3 N/mm ²	at max. temperature of 60° C and max. pres- sure of 0,3 N/mm ²	at max. temperature of 60° C and max. pres- sure of 0,3 N/mm ²	at max. temperature of 60° C and max. pres- sure of 0,3 N/mm ²	at max. temperature of 60° C and max. pres- sure of 0,3 N/mm ²
 Max. Temperature in use	80° C (short-term)	80° C (short-term)	80° C (short-term)	80° C (short-term)	80° C (short-term)
 Light fastness (EN 438- 2:2019, section 27)	no results so far	no results so far	no results so far	no results so far	Grey scale min. 4
 Rollable	not possible	not possible	not possible	not possible	not possible
Resistance to staining (EN 438-2:2019, section 26): Group 1 and 2: Group 3:	5 4	5 4	5 4	5 4	5 4
Resistance to scratching (EN 438-2:2019, section 25):	Grade 3	Grade 3	Grade 3	Grade 3	Grade 3
Resistance to surface wear (EN 438-2:2019, section 10): Revolutions (min.) Initial abrasion point	>150	>150	>150	>150	>150

HOMAPAL® SRM SCRATCH RESISTANT MATT

TECHNICAL DATA SHEET

MAGNETIC BOARDS

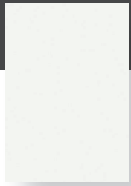

8296 SRM
Magnetic Board
White SRM

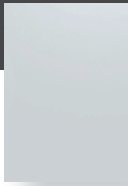

8298 SRM
Magnetic Board
Light Grey SRM

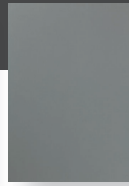

8295 SRM
Magnetic Board
Stone Grey SRM



8293 SRM
Magnetic Board
Macchiato SRM



8231 SRM
Magnetic Board
Alu Crossed-Brushed
Natural SRM

GENERAL INFORMATION

Due to an iron foil which is embedded in the laminate a very high magnetic effect is achieved. As such, large-format documents, e.g. plans, posters and other objects, can be easily fixed in place with magnets and then removed again without a trace. HOMAPAL® SRM Magnetic boards are decorative magnetic laminates with a surface consisting of a thin melamine layer¹. This melamine layer is protected by a thin UV-Laquer finish. ^{1= exception 8231 SRM, Aluminium instead of melamine}



CARE / CLEANING

A soft, lint-free cloth and a mild cleaning agent should always be used for cleaning. Strongly alkaline, strongly acidic, or cleaning agents with abrasive components must not be used. Alternative cleaning agents should only be used after consultation with HOMAPAL Application Technology.

PROCESSING INFORMATION:

HOMAPAL® SRM Magnetic boards **cannot** be sawn, drilled or milled as with all standard laminates (HPL) due to the embedded iron foil.



IMPORTANT NOTE

Please note that due to the used material during processing **flying sparks might be produced**. Furthermore, it has to be taken into consideration that with double-sided decorative magnetic boards (elements, compact magnetic board) the laminate must be slitted beforehand on the bottom side in order to make sure that a clean cut is achieved on both sides of the magnetic board.

The resulting cut edges can be sharp. Under certain circumstances small, hot metal chips could arise. It is therefore necessary to wear gloves and safety goggles! When processing always pay attention to the same direction, otherwise there will be changes in the appearance of the boards!

When sawing the magnetic boards in our plant, we achieve the best results with the following parameters:

APPLICATION AREAS

Only use indoors, vertically and horizontally. The SRM lacquering provides properties to the surface according to EN 438-Part-3:2016 (HGS) regarding to resistance to scratching (test 25, grade 3), resistance to surface wear (test 10, grade 3, initial abrasion point 150) and resistance to staining (test 26).

SAW BLADE (COLD-TIP-CUTTING SAW BLADE AGEFA)

Diameter (mm)	305
Thickness of corpus (mm)	2,2
Thickness in Area of teeth (mm)	1,8
Number of teeth	60

PROCESSING

Speed (U/min)	1500
Forward feed (m/min)	8

When cutting, the decor finish should always be at the top. Sawn or milled edges can be treated with a fine file or sandpaper.

HOMAPAL® SRM Magnetic boards should be used in well air-conditioned rooms. Drying of the surface by too dry room air conditions or direct heat influence should be avoided (risk of cracking). A short-term temperature influence on the laminate up to 60°C is possible.

HOMAPAL® SRM SCRATCH RESISTANT MATT

TECHNICAL DATA SHEET

MAGNETIC BOARDS

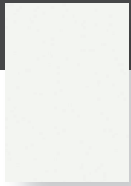

8296 SRM
Magnetic Board
White SRM

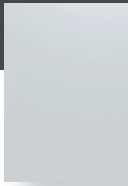

8298 SRM
Magnetic Board
Light Grey SRM

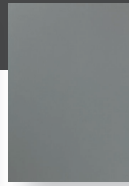

8295 SRM
Magnetic Board
Stone Grey SRM



8293 SRM
Magnetic Board
Macchiato SRM



8231 SRM
Magnetic Board
Alu Crossed-Brushed
Natural SRM

SUBSTRATE:

All standard substrates suitable for laminates are also suitable for HOMAPAL® SRM Magnetic boards. It is to be ensured that the moisture content of the substrate is not higher than that of the HOMAPAL® SRM Magnetic board (see Conditioning).



GLUEING

Commercially available adhesives and glues such as PVAC glue, two-component adhesives (epoxy) and neoprene contact adhesives are recommended. Exception: Urea bonding adhesives are not suitable. Comply with the manufacturer processing instructions in all cases. Never use water-based adhesives when applying moisture-proof materials. The moisture in the adhesive cannot dissipate and, therefore, the adhesive bond cannot dry.

STORAGE AND CONDITIONING

As with standard HPL products, HOMAPAL® SRM Magnetic boards must also be stored in a closed storeroom protected against moisture and UV radiation. Storage should be in a standard climate, i.e. approx. 18-25°C and 50-60% relative humidity.

The panel is covered with a protective foil upon completion of the final inspection. **Our protective foil is only a transport protection.** This does not absolve you from a timely incoming inspection (prior inspection of colour, colour uniformity and other quality characteristics of the laminate). The protective foil has to be removed before further processing. The surface protected by the removable protective foil should not be exposed to light for a long time. There is a risk that the foil will become more difficult to remove. (Use top cover!) The protective foil is not impermeable to liquids.

To avoid changes to the adhesive strength of the protective foil on the panel surface, the storage temperature should not deviate from the above specified temperatures by more than $\pm 10^\circ\text{C}$ during longer storage periods.

Laminates are to be stored fully supported and horizontal. The best conditioning is achieved in the room climate of the later area of application. This conditioning is recommended because materials that are processed in an excessively moist condition will tend towards expansion over time, and materials that are too dry will tend towards shrinking. All materials should be conditioned together for at least 48 hours.

Note: Always carry panels flat to avoid bends and cracks in the surface.

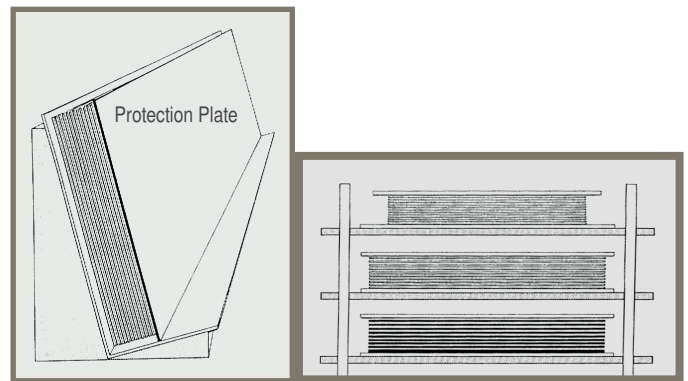

BALANCING

Stresses always arise between two different materials that are joined together. Therefore, a substrate must be covered on both sides with materials that are subject to the same dimensional changes under the influence of heat and moisture (conditioning of all materials). This applies in particular if the finished composite panel is to be self-supporting and is not held by a rigid construction. The larger the areas to be covered, the more attention is to be paid to the choice of the backing type, a symmetrical construction and the density and rigidity of the substrate. Our experience shows that substrates of a thickness ≤ 13 mm are critical in terms of the flatness of the composite element.

Fundamentally, factors such as the rigidity and symmetrical construction of the substrate, uniform appliance of adhesive and press temperature, as well as the size and angle of attachment of the object have an over-proportional influence here. The best results are always achieved through the use of the same laminate from the same manufacturer on both the front and rear sides. Both sides must always be glued to the substrate with the same running or finish direction on both sides (never at right-angles to each other).

To keep costs low, the use of second-choice laminates of the same material, or special backing material without the finish quality of the top layer is recommended. The use of other materials as backing cannot be recommended - even if the physical characteristics are as close as possible to those of HOMAPAL® SRM Magnetic boards - because the results can never be predicted with certainty.

HOMAPAL® SRM SCRATCH RESISTANT MATT TECHNICAL DATA SHEET MAGNETIC BOARDS

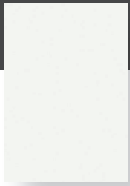

8296 SRM
Magnetic Board
White SRM

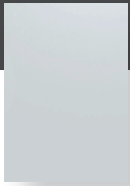

8298 SRM
Magnetic Board
Light Grey SRM

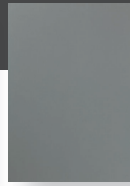

8295 SRM
Magnetic Board
Stone Grey SRM



8293 SRM
Magnetic Board
Macchiato SRM



8231 SRM
Magnetic Board
Alu Crossed-Brushed
Natural SRM

DISPOSAL

HOMAPAL® laminates are not classed as hazardous substances or dangerous goods. Waste can be incinerated in officially approved industrial combustion plants or deposited in controlled landfills, according to local regulations. High pressure laminate waste is classified as “other hardened plastics” i.e., it is similar to domestic waste.

HOMAPAL LAMINATE IN THE EVENT OF FIRE

HOMAPAL® SRM magnetic boards: As with any other material, in the event of incomplete combustion the smoke may contain toxic substances. The same fire-fighting techniques can be used on fires involving HOMAPAL® SRM magnetic boards that are used on wood-based building materials.

These specifications are based on our current knowledge and experience. They do not, however, exempt the processor from undertaking his own tests and examinations. A legally binding assurance of the properties or suitability for a specific purpose can not be derived from our specifications. We recommend the use of our technical advice service in the event of doubt. It is the responsibility of the processor of our products to observe any trade mark rights as well as all existing laws and regulations.

Status: August 2020